

**AGM BATTERY 90 AH – 850535**

**BATTERY SPECIFICATION**

- Maintenance-free service battery for campervans and motorhomes
- High vibration resistance
- Leak-proof
- Can be installed in any position (upright or lying)
- High cycle stability, also ideal for use in combination with a solar system
- Low self-discharge

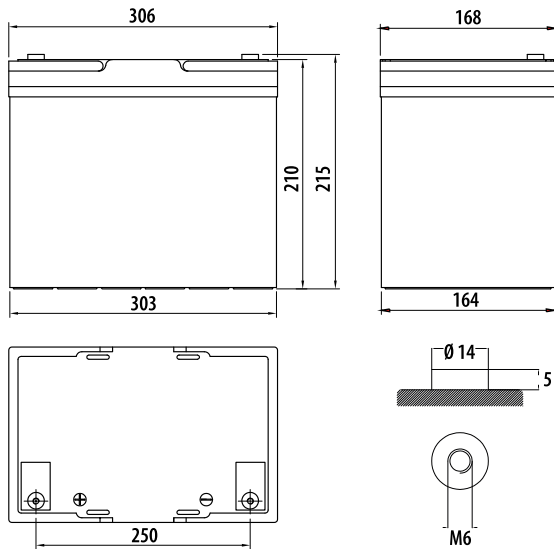

Included:  
2x battery terminal  
adaptor



**Performance Characteristics**

Nominal Voltage	12V
Number of cell	6
<b>Nominal Capacity (25°C)</b>	
20 hour rate (4.50A, 10.8V)	90Ah
10 hour rate (8.86A, 10.8V)	88.6Ah
5 hour rate (16.1A, 10.5V)	80.5Ah
1 hour rate (61.1A, 9.6V)	61.1Ah
Fully Charged battery 77°F (25°C)	5.1 mOhms
<b>Self-Discharge</b>	
3% of capacity declined per month at 20°C	
<b>Operating Temperature Range</b>	
Discharge	-20~60°C
Charge	-10~60°C
Storage	-20~60°C
<b>Max. Discharge Current (25°C)</b>	800A(5s)
<b>Short Circuit Current</b>	2000A
<b>Charge Methods: Constant Voltage Charge (25°C)</b>	
Cycle use	2.30 - 2.35VPC
Maximum charging current	27A
Temperature compensation	-30mV/°C
Standby use	2.23 - 2.27VPC
Temperature compensation	-20mV/°C

**Discharge Constant Current (Amperes at 25°C)**

End Point Volts/Cell	5min	10min	15min	30min	45min	1h	3h	5h	10h	20h
1.60V	274	210	168	97.6	73.2	61.1	26.7	17.1	8.98	4.65
1.65V	256	200	157	92.7	70.1	55.8	25.7	16.9	8.96	4.61
1.70V	240	179	149	87.8	66.6	55.2	24.8	16.6	8.93	4.54
1.75V	217	168	138	85.2	64.2	53.8	24.0	16.1	8.90	4.52
1.80V	193	157	128	82.1	61.8	51.6	22.9	15.6	8.86	4.50

**Discharge Constant Power (Watts at 25°C)**

End Point Volts/Cell	5min	10min	15min	30min	45min	1h	2h	3h	5h
1.60V	491	359	299	184	142	115	64.7	47.8	32.1
1.65V	479	350	294	176	136	110	63.3	47.7	31.7
1.70V	430	332	276	167	126	105	61.0	46.3	31.3
1.75V	405	330	273	163	125	101	59.0	45.0	30.5
1.80V	372	302	259	159	123	99.5	58.3	44.8	30.1

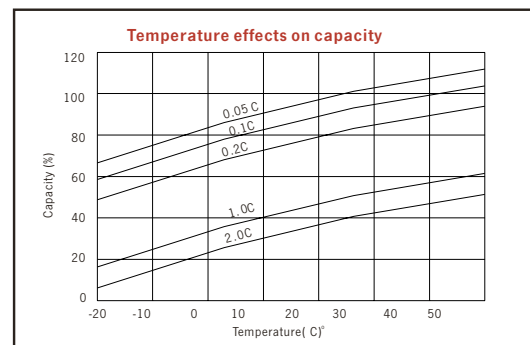
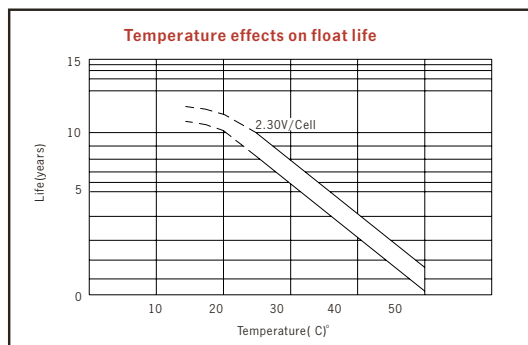
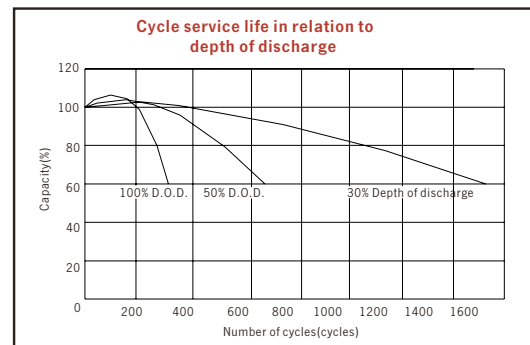
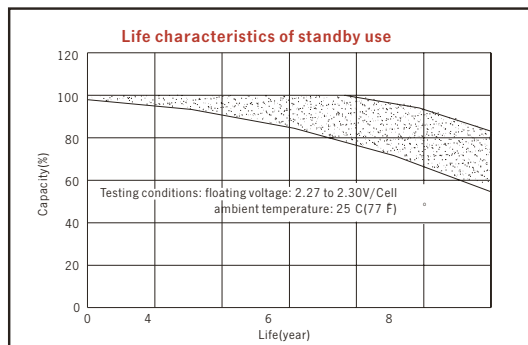
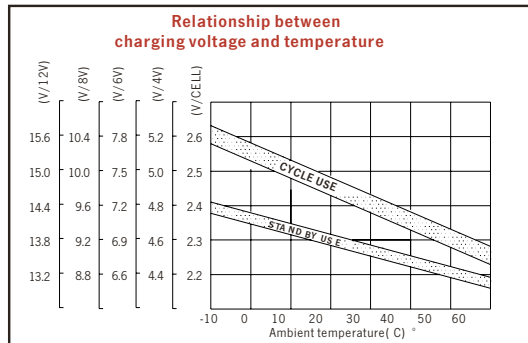
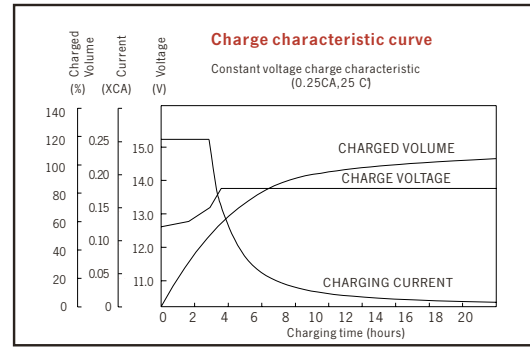
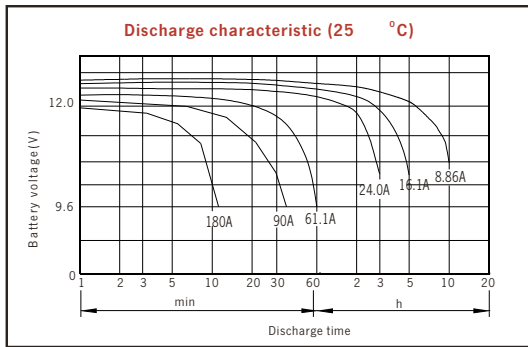

**WARRANTY**

The warranty period is 36 months. Reimo reserves the right to rectify eventual defaults. The guarantee is excluded for all damages caused by faulty use or improper handling.

Liability limitations: In no case Reimo will be reliable for collateral-, secondary- or indirect damages, costs, expenditure, missed benefits or missed earnings. The indicated sales price of the product is representing the equivalent value of Reimo's liability limitations.

**DISPOSAL**

Dispose of the packaging material in the recycling stations provided.

According to the European WEEE Directive, electrical and electronic devices as well as batteries must not be disposed of with household waste (indicated by the crossed-out dustbin). Their components must be recycled or disposed of separately because toxic and hazardous components can cause lasting damage to the environment if disposed of improperly.

According to the Electrical and Electronic Equipment Act (ElektroG), consumers are obliged to return electrical and electronic equipment free of charge at the end of its service life to the manufacturer, the point of sale or to public collection points set up for this purpose by the cities and municipalities. You can obtain further information directly from your municipal administration.