

AGM BATTERY 134 AH – 850537

BATTERY SPECIFICATION

- Maintenance-free service battery for campervans and motorhomes
- High vibration resistance
- Leak-proof
- Can be installed in any position (upright or lying)
- High cycle stability, also ideal for use in combination with a solar system
- Low self-discharge

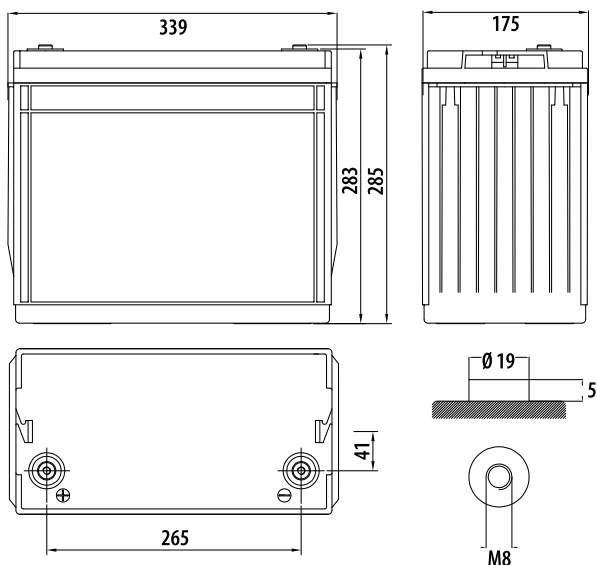

Included:
2x battery terminal
adapter

Performance Characteristics

Nominal Voltage	12V
Number of cell	6
Nominal Capacity (25°C)	
20 hour rate (6.7A, 10.5V)	134Ah
10 hour rate (13.1A, 10.5V)	131Ah
5 hour rate (22.1A, 10.5V)	110.5Ah
1 hour rate (83.6A, 9.6V)	83.6Ah
Fully Charged battery 77°F (25°C)	≤ 3.8 mOhms

Self-Discharge

3% of capacity declined per month at 20°C

Operating Temperature Range

Discharge	-20~60°C
Charge	-10~60°C
Storage	-20~60°C

Max. Discharge Current (25°C) 950A(5s)

Short Circuit Current 2250A

Charge Methods: Constant Voltage Charge (25°C)

Cycle use	14.4 - 14.7VPC
Maximum charging current	40.2A
Temperature compensation	-30mV/°C
Standby use	13.6 - 13.8VPC
Temperature compensation	-20mV/°C



Discharge Constant Current (Amperes at 25°C)

End Point-Volts/Cell	10min	15min	30min	1h	3h	5h	10h	20h
1.60V	294	239	135	83.6	34.3	23.3	13.3	6.80
1.65V	278	230	131	83.0	33.5	23.0	13.2	6.78
1.70V	263	220	127	81.3	32.8	22.5	13.1	6.75
1.75V	247	210	122	78.9	32.1	22.1	13.1	6.70
1.80V	232	201	119	76.3	31.2	21.7	13.0	6.67

Discharge Constant Power (Watts at 25°C)

End Point-Volts/Cell	10min	15min	30min	45min	1h	2h	3h	5h
1.60V	531	423	256	181	168	92.6	66.0	45.9
1.65V	504	409	248	178	165	91.1	65.2	45.7
1.70V	478	396	242	174	163	89.4	64.4	45.3
1.75V	453	382	234	169	158	87.8	63.7	45.0
1.80V	423	369	226	166	153	86.9	62.5	44.6

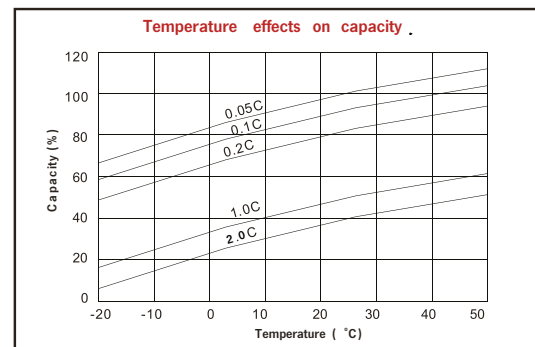
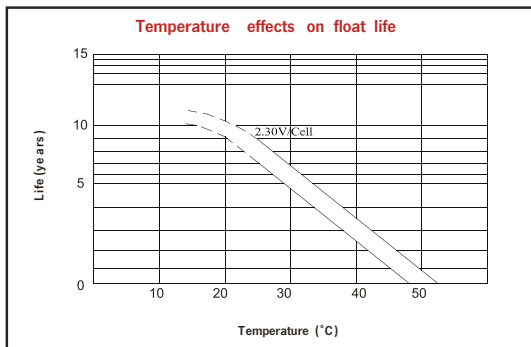
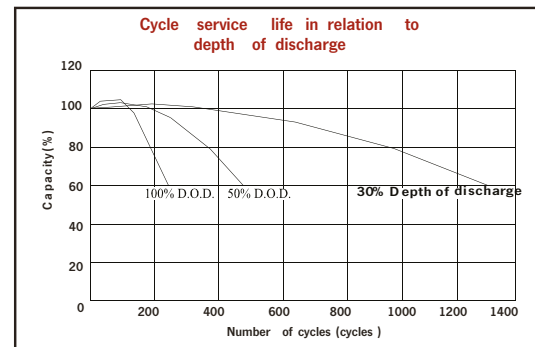
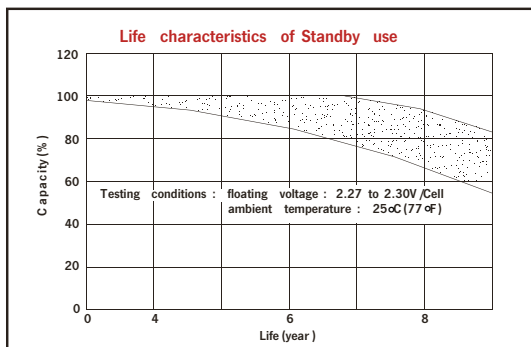
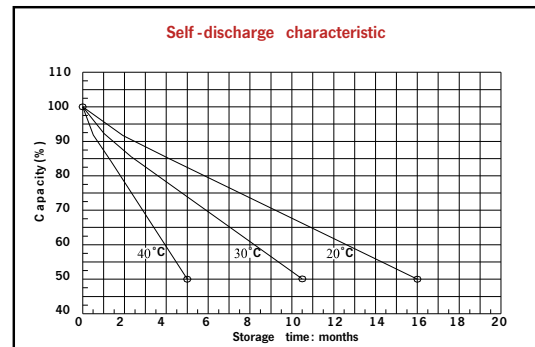
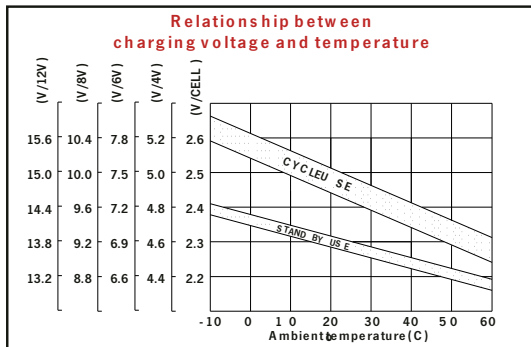
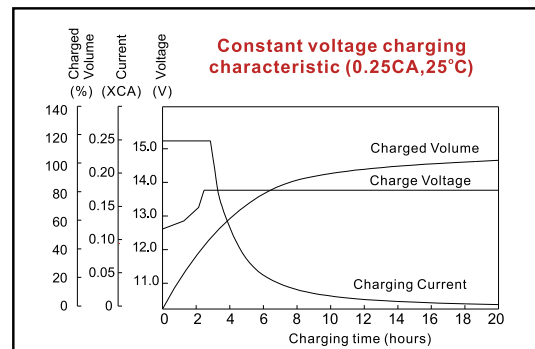
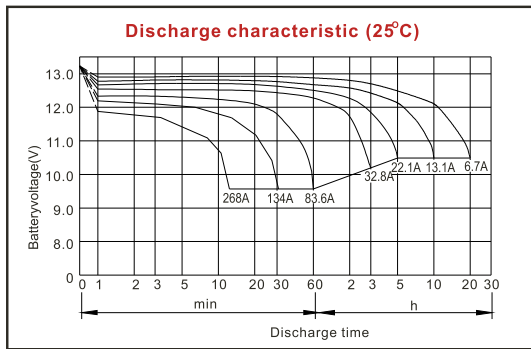

WARRANTY

The warranty period is 36 months. Reimo reserves the right to rectify eventual defaults. The guarantee is excluded for all damages caused by faulty use or improper handling.

Liability limitations: In no case Reimo will be reliable for collateral-, secondary- or indirect damages, costs, expenditure, missed benefits or missed earnings. The indicated sales price of the product is representing the equivalent value of Reimo's liability limitations.

DISPOSAL

Dispose of the packaging material in the recycling stations provided.

According to the European WEEE Directive, electrical and electronic devices as well as batteries must not be disposed of with household waste (indicated by the crossed-out dustbin). Their components must be recycled or disposed of separately because toxic and hazardous components can cause lasting damage to the environment if disposed of improperly.

According to the Electrical and Electronic Equipment Act (ElektroG), consumers are obliged to return electrical and electronic equipment free of charge at the end of its service life to the manufacturer, the point of sale or to public collection points set up for this purpose by the cities and municipalities. You can obtain further information directly from your municipal administration.