

UK
This tent should be erected by at least two persons.

DE
Dieses Zelt sollte, wenn möglich, von zwei Personen aufgestellt werden.

DK
Dette telt bør rejses af mindst to personer.

NO
Dette teltet skal settes opp av minst to personer.

FR
Cette tente doit être montée par au moins deux personnes.

NL
Deze tent moet opgezet worden door minstens twee personen.

CZ
Tento stan musí stavět nejméně dvě osoby.

PITCHING

PITCH TIME



6 min.



13 min.

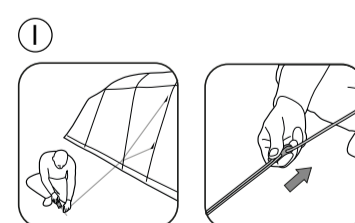
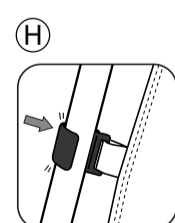
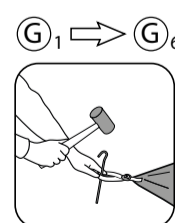
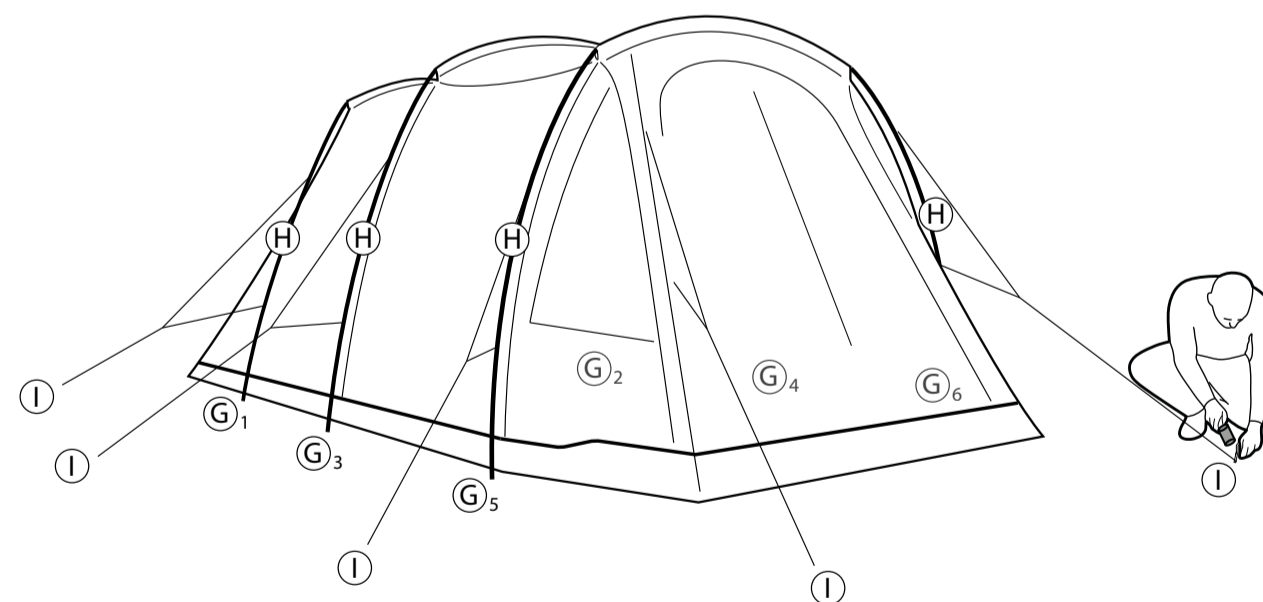
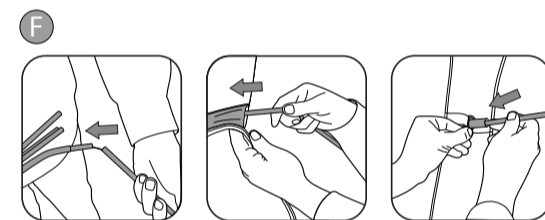
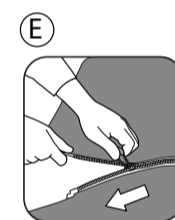
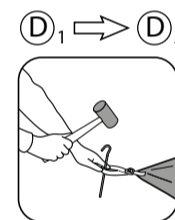
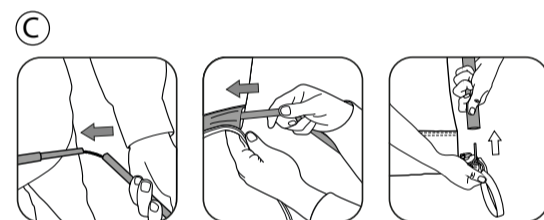
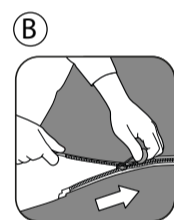
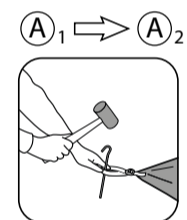
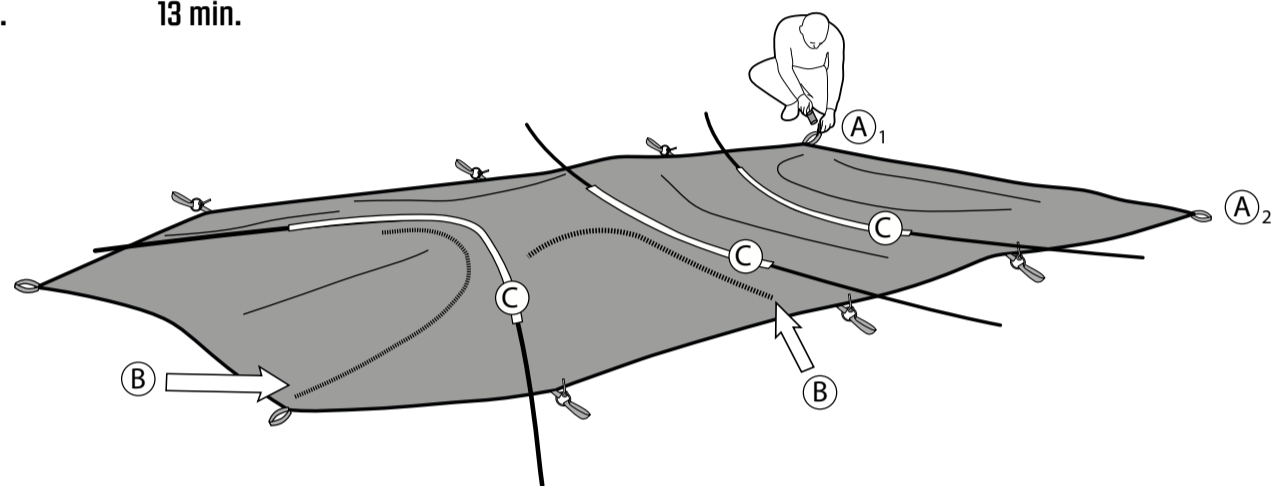

FIND OUT!
See our videos
HOW TO PITCH YOUR TENT?
www.youtube.com/user/Outwelltents
HOW TO CLEAN AND MAINTAIN YOUR TENT?
www.outwell.com/maintenance

FINDEN SIE ES HERAUS!
Finden Sie es in unseren videos
WIE BAUE ICH MEIN ZELT AUF?
www.youtube.com/user/Outwelltents
WIE REINIGE UND PFLEGE ICH MEIN ZELT?
www.outwell.com/maintenance

SÅDAN GØR DU!
Se vores videoer
SÅDAN SÆTTER DU DIT TELT OP!
www.youtube.com/user/Outwelltents
SÅDAN RENGØRER OG VEDLIGEHOLDER DU DIT TELT!
www.outwell.com/maintenance

FINN UT MER!
Se videoene våre
HVORDAN SETTER DU OPP TELTET DITT?
www.youtube.com/user/Outwelltents
HVORDAN RENGJØR OG VEDLIKEHOLDER DU TELTET?
www.outwell.com/maintenance

DÉCOUVREZ!
Regardez nos vidéos
COMMENT MONTER VOTRE TENTE?
www.youtube.com/user/Outwelltents
COMMENT NETTOYER ET ENTRETIENIR VOTRE TENTE?
www.outwell.com/maintenance

ONTDEK HET HIER!
Bekijk onze video's
HOE ZET U UW TENT OP?
www.youtube.com/user/Outwelltents
HOE REINIGT EN ONDERHOUDT U UW TENT?
www.outwell.com/maintenance

NEPŘEHLÉDNĚTE!
Podívejte se na naše videa
JAK POSTAVIT STAN?
www.youtube.com/user/Outwelltents
JAK ČISTIT A STARAT SE O STAN?
www.outwell.com/maintenance

