

AGM BATTERY 60 AH – 850534

BATTERY SPECIFICATION

- Maintenance-free service battery for campervans and motorhomes
- High vibration resistance
- Leak-proof
- Can be installed in any position (upright or lying)
- High cycle stability, also ideal for use in combination with a solar system
- Low self-discharge

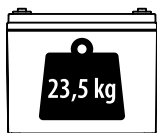
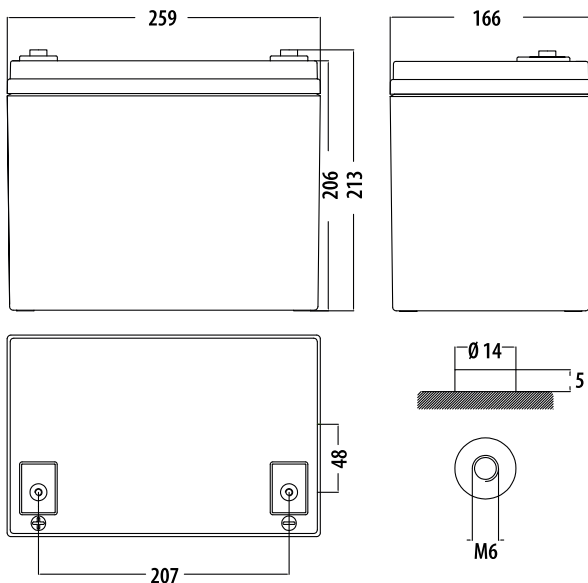

Included:
2x battery terminal
adaptor

Performance Characteristics

Nominal Voltage	12V
Number of cell	6
Nominal Capacity (25°C)	
10 hour rate (6.0A, 10.8V)	60.0Ah
5 hour rate (10.7A, 10.5V)	53.5Ah
1 hour rate (41.0A, 9.6V)	41.1Ah
Fully Charged battery 77°F (25°C)	≤7.0mOhms
Self-Discharge	
3% of capacity declined per month at 20°C	
Operating Temperature Range	
Discharge	-20~60°C
Charge	-10~60°C
Storage	-20~60°C
Max. Discharge Current (25°C)	600A(5s)
Short Circuit Current	1450A
Charge Methods: Constant Voltage Charge (25°C)	
Cycle use	2.40 - 2.45VPC
Maximum charging current	18.0A
Temperature compensation	-30mV/°C
Standby use	2.20 - 2.30VPC
Temperature compensation	-20mV/°C



Discharge Constant Current (Amperes at 25°C)

End Point-Volts/Cell	10min	15min	30min	45min	1h	3h	5h	10h
1.60V	1 49	1 15	6 7.0	5 0.3	4 1.0	1 6.7	1 1.4	6 .60
1.65V	1 43	1 10	6 5.0	4 8.9	3 9.4	1 6.3	1 1.1	6 .45
1.70V	1 33	1 05	6 3.0	4 7.6	3 9.2	1 6.3	1 0.9	6 .18
1.75V	1 23	9 9.4	6 0.9	4 6.2	3 8.9	1 6.0	1 0.7	6 .15
1.80V	1 12	9 2.0	5 8.7	4 4.9	3 6.6	1 5.2	1 0.5	6 .00

Discharge Constant Power (Watts at 25°C)

End Point-Volts/Cell	10min	15min	30min	45min	1h	3h	5h	10h
1.60V	2 59	2 00	1 22	9 4.1	7 7.6	3 3.0	2 2.2	1 2.2
1.65V	2 48	1 90	1 16	9 2.6	7 5.8	3 2.8	2 2.1	1 2.1
1.70V	2 34	1 87	1 14	9 0.7	7 4.1	3 2.1	2 1.7	1 2.0
1.75V	2 20	1 83	1 12	8 8.7	7 2.4	3 1.4	2 1.4	1 1.9
1.80V	2 05	1 74	1 09	8 7.9	7 1.0	3 0.7	2 0.8	1 1.7

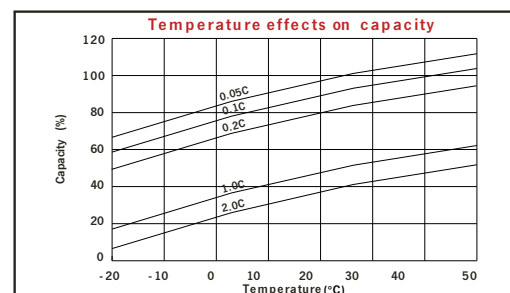
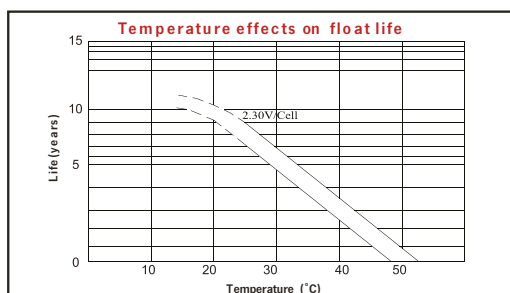
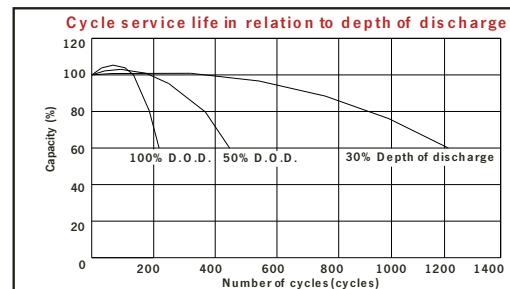
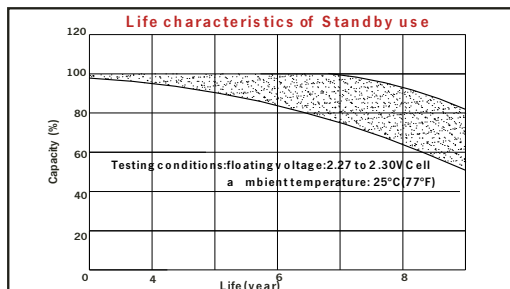
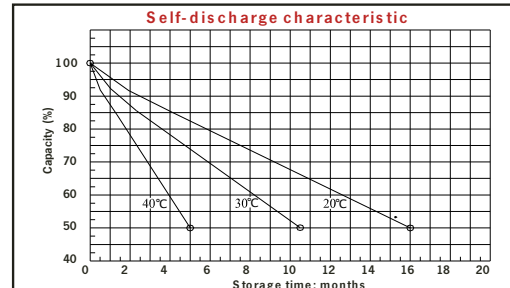
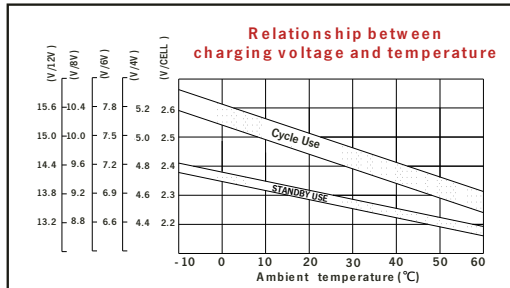
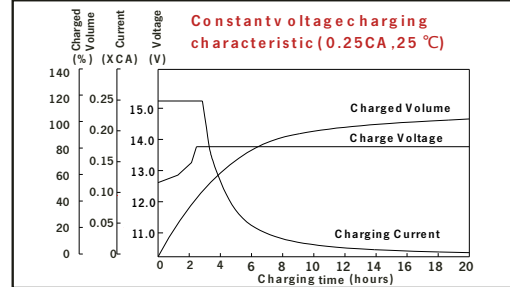
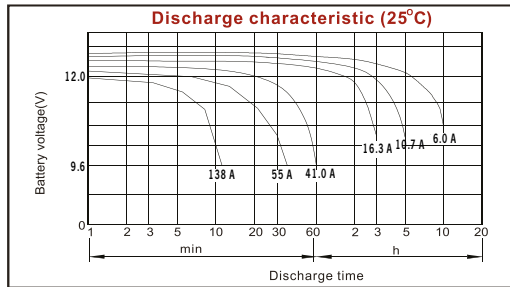
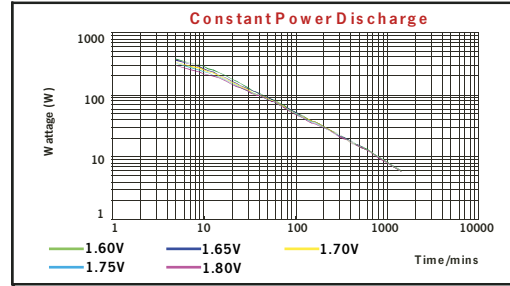
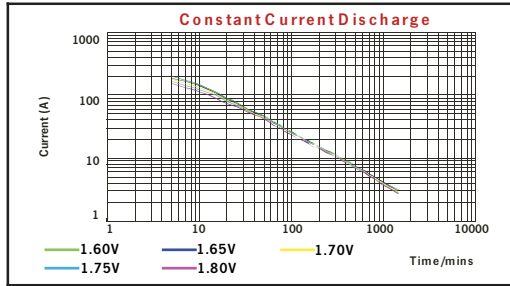

WARRANTY

The warranty period is 36 months. Reimo reserves the right to rectify eventual defaults. The guarantee is excluded for all damages caused by faulty use or improper handling.

Liability limitations: In no case Reimo will be reliable for collateral-, secondary- or indirect damages, costs, expenditure, missed benefits or missed earnings. The indicated sales price of the product is representing the equivalent value of Reimo's liability limitations.

DISPOSAL

Dispose of the packaging material in the recycling stations provided.

According to the European WEEE Directive, electrical and electronic devices as well as batteries must not be disposed of with household waste (indicated by the crossed-out dustbin). Their components must be recycled or disposed of separately because toxic and hazardous components can cause lasting damage to the environment if disposed of improperly.

According to the Electrical and Electronic Equipment Act (ElektroG), consumers are obliged to return electrical and electronic equipment free of charge at the end of its service life to the manufacturer, the point of sale or to public collection points set up for this purpose by the cities and municipalities. You can obtain further information directly from your municipal administration.